



JDK Serie / JDK series

JDK-S-60 / JDK-S-80 / JDK-S-100 / JDK-S-120

Produktmerkmale

- Kompaktes Design
- Energieeffizient
- Schutzschalter inklusive
- Optional auch mit Signalkabel
- Schlauchstück im Lieferumfang
- Metallgehäuse

Product characteristics

- Compact design
- Low energy consumption
- Protective switch inclusive
- Optional with signal cable
- Connecting hose incl. in delivery
- metal housing

Abmessungen / Dimensions

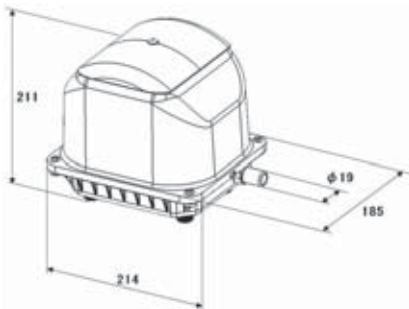

Technische Daten / Technical data

Modell / Model			JDK-S-60	JDK-S-80	JDK-S-100	JDK-S-120
Volumenstrom ¹⁾ / Air flow ¹⁾	l/min	0 mbar	130	145	150	190
		50 mbar	125	130	145	180
		100 mbar	105	115	130	160
		150 mbar	85	90	110	140
		200 mbar	60	75	95	120
Spannung ²⁾ / Voltage ²⁾	VAC		230			
Leistungsaufnahme / Power consumption	W	200 mbar	40	50	75	95
Geräuschpegel / Noise level	dB(A)		≤ 36	≤ 38	≤ 42	≤ 45
Abmessungen / Dimensions	mm	L x B x H L x W x H	214 x 185 x 211			
Schlauchanschluss / Connection	mm	Ø außen Ø outside	19			
Nettogewicht / Net weight	kg		6.5			

¹⁾ Die tatsächliche Leistung kann bis zu +/- 10% von den Angaben abweichen

²⁾ Werte bei 50 Hz

¹⁾ Product performance may vary +/- 10% from performance curves

²⁾ Values at 50 Hz

Ersatzteile / Zubehör Spare Parts / Accessories

Ersatzteile / Spares	Bestell-Nr. / Code
Reparatur-Kit / Service Kit	K-JDK-60/80-D K-JDK-100/120-D
Membran-Set / Diaphragm Sets	D-JDK-60/120
Filter / Filter	FILTER-JDK-60/120
Magnet / Magnet	K-JDK-60/120-M
Zubehör / Accessories	
Manometer / Pressure Gauge	BP1
Drucksicherheitsventil / Pressure Relief Valve	SE11

Leistungsdaten / Performance data

